

Data sheet | Item number: 280-606

4-conductor carrier terminal block; for DIN-rail 35 x 15 and 35 x 7.5; 2.5 mm²; CAGE CLAMP®

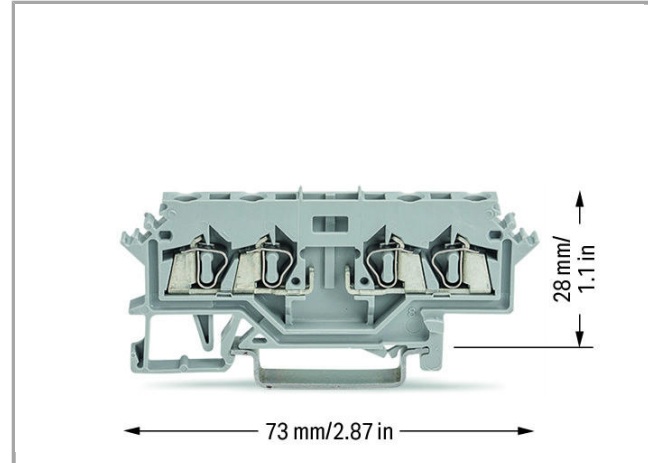

280-606

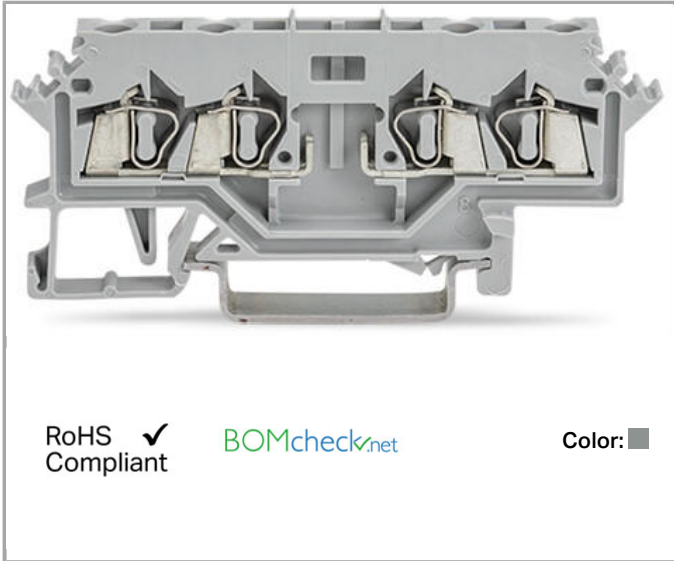

Item description

Note:

Terminating Aluminum Conductors

WAGO spring clamp terminal blocks are suitable for solid aluminum conductors up to 4 mm²/12 AWG if WAGO "Alu-Plus" Contact Paste is used for termination.

"Alu-Plus" Contact Paste Advantages:

- Automatically destroys the oxide film during clamping.
- Prevents fresh oxidation at the clamping point.
- Prevents electrolytic corrosion between aluminum and copper conductors (in the same terminal block).
- Provides long-term protection against corrosion.

Using terminal blocks with CAGE CLAMP® Spring Pressure Connection Technology, **aluminum conductors must first be cleaned with a blade** and then immediately be inserted into the clamping units filled with "Alu-Plus" Contact Paste.

It is also possible to apply WAGO "Alu-Plus" **additionally** on the whole surface of the aluminum conductor before termination.

Please note that the nominal currents must be adapted to the reduced conductivity of the aluminum conductors:

2.5 mm² (14 AWG) = 16 A

4 mm² (12 AWG) = 22 A

Data

Electrical data

Ratings per IEC/EN 60664-1

| | |
|---------------------------------|-------|
| Rated voltage (III / 3) | 400 V |
| Rated impulse voltage (III / 3) | 6 kV |
| Rated current | 10 A |

Connection data

| | |
|-----------------------------------|--|
| Connection technology | CAGE CLAMP® |
| Actuation type | Operating tool |
| Connectable conductor materials | Copper Aluminum |
| Solid conductor | 0.08 ... 2.5 mm ² / 28 ... 12 AWG |
| Fine-stranded conductor | 0.08 ... 2.5 mm ² / 28 ... 12 AWG |
| Strip length | 8 ... 9 mm / 0.31 ... 0.35 inch |
| Note (conductor cross-section) | 12 AWG: THHN, THWN |
| Total number of connection points | 4 |
| Total number of potentials | 2 |
| Number of levels | 1 |
| Type of wiring | Front-entry wiring |

Geometrical Data

| | |
|---------------------------------------|--------------------|
| Width | 5 mm / 0.197 inch |
| Height from upper-edge of DIN-35 rail | 28 mm / 1.102 inch |
| Depth | 73 mm / 2.874 inch |

Mechanical data

| | |
|------------------|--------------|
| Design | horizontal |
| Type of mounting | DIN-35 rail |
| Marking level | Side marking |

Material Data

| | |
|---------------------|----------------------|
| Color | gray |
| Insulating material | Polyamide 66 (PA 66) |
| Fire load | 0.139 MJ |
| Weight | 8.17 g |

Commercial data



| | |
|-------------------|----------------------------------|
| Product Group | 1 (Rail Mounted Terminal Blocks) |
| Country of origin | DE |
| GTIN | 4044918635363 |

Customs Tariff No.





8536901000

Approvals / Certificates

Country specific Approvals

| Logo | Approval | Additional Approval Text | Certificate name |
|--|---------------------------------|--------------------------|------------------|
|  | CCA DEKRA Certification B.V. | EN 60947 | 2157201.01 |
|  | CSA DEKRA Certification B.V. | C22.2 | 1536071 |

Ship Approvals









| Logo | Approval | Additional Approval Text | Certificate name |
|---|--|--------------------------|--------------------------|
|  | ABS American Bureau of Shipping | EN 60947 | 14- HG1293677- PDA |
|  | BV Bureau Veritas S.A. | EN 60947 | 07436/E0 BV |
|  | DNV GL Det Norske Veritas, Germanischer Lloyd | - | TAE00001V2 |
|  | LR Lloyds Register | EN 60947 | 91/20112 (E9) |

UL-Approvals

| Logo | Approval | Additional Approval Text | Certificate name |
|--|--------------------------------------|--------------------------|---------------------|
|  | UL Underwriters Laboratories Inc. | UL 1059 | 20170731- E45172 |

Compatible products

Female plug

| | | | |
|--|--|------------------|---------|
|  | Item no.: 232-132/005-000 Female connector for rail-mount terminal blocks; straight; Pin spacing 5 mm; 2-pole | /005-000 | 232-132 |
|  | Item no.: 232-132/005-000/039-000 Female connector for rail-mount terminal blocks; straight; Locking lever; Pin spacing 5 mm; 3-pole | /005-000/039-000 | 232-132 |
|  | Item no.: 232-133/005-000 Female connector for rail-mount terminal blocks; straight; Pin spacing 5 mm; 3-pole | /005-000 | 232-133 |
|  | Item no.: 232-133/005-000/039-000 Female connector for rail-mount terminal blocks; straight; Locking lever; Pin spacing 5 mm; 3-pole | /005-000/039-000 | 232-133 |
|  | Item no.: 232-134/005-000 Female connector for rail-mount terminal blocks; straight; Pin spacing 5 mm; 4-pole | /005-000 | 232-134 |
|  | Item no.: 232-134/005-000/039-000 Female connector for rail-mount terminal blocks; straight; Locking lever; Pin spacing 5 mm; 4-pole | /005-000/039-000 | 232-134 |
|  | Item no.: 232-135/005-000 Female connector for rail-mount terminal blocks; straight; Pin spacing 5 mm; 5-pole | /005-000 | 232-135 |
|  | Item no.: 232-135/005-000/039-000 Female connector for rail-mount terminal blocks; straight; Locking lever; Pin spacing 5 mm; 5-pole | /005-000/039-000 | 232-135 |
|  | Item no.: 232-136/005-000 Female connector for rail-mount terminal blocks; straight; Pin spacing 5 mm; 6-pole | /005-000 | 232-136 |
|  | Item no.: 232-136/005-000/039-000 Female connector for rail-mount terminal blocks; straight; Locking lever; Pin spacing 5 mm; 6-pole | /005-000/039-000 | 232-136 |
|  | Item no.: 232-137/005-000 Female connector for rail-mount terminal blocks; straight; Pin spacing 5 mm; 7-pole | /005-000 | 232-137 |
| | Item no.: 232-137/005-000/039-000 Female connector for rail-mount terminal blocks; straight; Locking lever; Pin spacing 5 mm; 7-pole | /005-000/039-000 | 232-137 |

**Item no.: 232-138/005-000**

Female connector for rail-mount terminal blocks; straight; Pin spacing 5 mm; 8-pole

/005-000

232-138

Item no.: 232-138/005-000/039-000

Female connector for rail-mount terminal blocks; straight; Locking lever; Pin spacing 5 mm; 8-pole

/005-000/039-000

232-138

Item no.: 232-139/005-000

Female connector for rail-mount terminal blocks; straight; Pin spacing 5 mm; 9-pole

/005-000

232-139

Item no.: 232-139/005-000/039-000

Female connector for rail-mount terminal blocks; straight; Locking lever; Pin spacing 5 mm; 9-pole

/005-000/039-000

232-139

Item no.: 232-140/005-000

Female connector for rail-mount terminal blocks; straight; Pin spacing 5 mm; 10-pole

/005-000

232-140

Item no.: 232-140/005-000/039-000

Female connector for rail-mount terminal blocks; straight; Locking lever; Pin spacing 5 mm; 10-pole

/005-000/039-000

232-140

Item no.: 232-142/005-000

Female connector for rail-mount terminal blocks; straight; Pin spacing 5 mm; 12-pole

/005-000

232-142

Item no.: 232-142/005-000/039-000

Female connector for rail-mount terminal blocks; straight; Locking lever; Pin spacing 5 mm; 12-pole

/005-000/039-000

232-142

Item no.: 232-146/005-000

Female connector for rail-mount terminal blocks; straight; Pin spacing 5 mm; 16-pole

/005-000

232-146

Item no.: 232-146/005-000/039-000

Female connector for rail-mount terminal blocks; straight; Locking lever; Pin spacing 5 mm; 16-pole

/005-000/039-000

232-146

Item no.: 232-147/005-000/039-000

Female connector for rail-mount terminal blocks; straight; Locking lever; Pin spacing 5 mm; 17-pole

/005-000/039-000

232-147

Item no.: 232-150/005-000

Female connector for rail-mount terminal blocks; straight; Pin spacing 5 mm; 20-pole

/005-000

232-150

Item no.: 232-150/005-000/039-000

Female connector for rail-mount terminal blocks; straight; Locking lever; Pin spacing 5 mm; 20-pole

/005-000/039-000















232-150















Item no.: 232-232/005-000















Female connector for rail-mount terminal blocks; angled; Pin spacing 5 mm; 2-pole















/005-000















232-232















| | | |
|--|---|-----------------------------|
|  | Item no.: 232-232/005-000/039-000 Female connector for rail-mount terminal blocks; angled; Locking lever; Pin spacing 5 mm; 2-pole | 232-232 /005-000/039-000 |
|  | Item no.: 232-233/005-000 Female connector for rail-mount terminal blocks; angled; Pin spacing 5 mm; 3-pole | 232-233 /005-000 |
|  | Item no.: 232-233/005-000/039-000 Female connector for rail-mount terminal blocks; angled; Locking lever; Pin spacing 5 mm; 3-pole | 232-233 /005-000/039-000 |
|  | Item no.: 232-234/005-000 Female connector for rail-mount terminal blocks; angled; Pin spacing 5 mm; 4-pole | 232-234 /005-000 |
|  | Item no.: 232-234/005-000/039-000 Female connector for rail-mount terminal blocks; angled; Locking lever; Pin spacing 5 mm; 4-pole | 232-234 /005-000/039-000 |
|  | Item no.: 232-235/005-000 Female connector for rail-mount terminal blocks; angled; Pin spacing 5 mm; 5-pole | 232-235 /005-000 |
|  | Item no.: 232-235/005-000/039-000 Female connector for rail-mount terminal blocks; angled; Locking lever; Pin spacing 5 mm; 5-pole | 232-235 /005-000/039-000 |
|  | Item no.: 232-236/005-000 Female connector for rail-mount terminal blocks; angled; Pin spacing 5 mm; 6-pole | 232-236 /005-000 |
|  | Item no.: 232-236/005-000/039-000 Female connector for rail-mount terminal blocks; angled; Locking lever; Pin spacing 5 mm; 6-pole | 232-236 /005-000/039-000 |
|  | Item no.: 232-237/005-000 Female connector for rail-mount terminal blocks; straight; Pin spacing 5 mm; 7-pole | 232-237 /005-000 |
|  | Item no.: 232-238/005-000 Female connector for rail-mount terminal blocks; angled; Pin spacing 5 mm; 8-pole | 232-238 /005-000 |
|  | Item no.: 232-239/005-000 Female connector for rail-mount terminal blocks; angled; Pin spacing 5 mm; 9-pole | 232-239 /005-000 |
|  | Item no.: 232-240/005-000 Female connector for rail-mount terminal blocks; angled; Pin spacing 5 mm; 10-pole | 232-240 /005-000 |
|  | Item no.: 232-240/005-000/039-000 Female connector for rail-mount terminal blocks; angled; Locking lever; Pin spacing 5 mm; 10-pole | 232-240 /005-000/039-000 |
|  | Item no.: 232-242/005-000 Female connector for rail-mount terminal blocks; angled; Pin spacing 5 mm; 12-pole | 232-242 /005-000 |















| | | |
|--|---|-----------------------------|
|  | Item no.: 232-242/005-000/039-000 Female connector for rail-mount terminal blocks; angled; Locking lever; Pin spacing 5 mm; 12-pole | 232-242 /005-000/039-000 |
|  | Item no.: 232-246/005-000 Female connector for rail-mount terminal blocks; angled; Pin spacing 5 mm; 16-pole | 232-246 /005-000 |
|  | Item no.: 232-246/005-000/039-000 Female connector for rail-mount terminal blocks; angled; Locking lever; Pin spacing 5 mm; 16-pole | 232-246 /005-000/039-000 |
|  | Item no.: 232-250/005-000 Female connector for rail-mount terminal blocks; angled; Pin spacing 5 mm; 20-pole | 232-250 /005-000 |
|  | Item no.: 232-250/005-000/039-000 Female connector for rail-mount terminal blocks; angled; Locking lever; Pin spacing 5 mm; 20-pole | 232-250 /005-000/039-000 |
|  | Item no.: 232-732/005-000 Female connector for rail-mount terminal blocks; straight; Pin spacing 7.5 mm; 2-pole | 232-732 /005-000 |
|  | Item no.: 232-733/005-000 Female connector for rail-mount terminal blocks; straight; Pin spacing 7.5 mm; 3-pole | 232-733 /005-000 |
|  | Item no.: 232-734/005-000 Female connector for rail-mount terminal blocks; straight; Pin spacing 7.5 mm; 4-pole | 232-734 /005-000 |
|  | Item no.: 232-734/005-000/039-000 Female connector for rail-mount terminal blocks; straight; Pin spacing 7.5 mm; 4-pole | 232-734 /005-000/039-000 |
|  | Item no.: 232-735/005-000 Female connector for rail-mount terminal blocks; straight; Pin spacing 7.5 mm; 5-pole | 232-735 /005-000 |
|  | Item no.: 232-735/005-000/039-000 Female connector for rail-mount terminal blocks; straight; Pin spacing 7.5 mm; 5-pole | 232-735 /005-000/039-000 |
|  | Item no.: 232-736/005-000 Female connector for rail-mount terminal blocks; straight; Pin spacing 7.5 mm; 6-pole | 232-736 /005-000 |
|  | Item no.: 232-736/005-000/039-000 Female connector for rail-mount terminal blocks; straight; Pin spacing 7.5 mm; 6-pole | 232-736 /005-000/039-000 |
|  | Item no.: 232-738/005-000 Female connector for rail-mount terminal blocks; straight; Pin spacing 7.5 mm; 8-pole | 232-738 /005-000 |

















| | | |
|--|--|-----------------------------|
|  | Item no.: 232-740/005-000 Female connector for rail-mount terminal blocks; straight; Pin spacing 7.5 mm; 10-pole | 232-740 /005-000 |
|  | Item no.: 232-742/005-000 Female connector for rail-mount terminal blocks; straight; Pin spacing 7.5 mm; 12-pole | 232-742 /005-000 |
|  | Item no.: 232-832/005-000 Female connector for rail-mount terminal blocks; angled; Pin spacing 7.5 mm; 2-pole | 232-832 /005-000 |
|  | Item no.: 232-833/005-000 Female connector for rail-mount terminal blocks; angled; Pin spacing 7.5 mm; 3-pole | 232-833 /005-000 |
|  | Item no.: 232-834/005-000 Female connector for rail-mount terminal blocks; angled; Pin spacing 7.5 mm; 4-pole | 232-834 /005-000 |
|  | Item no.: 232-836/005-000 Female connector for rail-mount terminal blocks; straight; Pin spacing 7.5 mm; 6-pole | 232-836 /005-000 |
|  | Item no.: 232-836/005-000/039-000 Female connector for rail-mount terminal blocks; angled; Pin spacing 7.5 mm; 6-pole | 232-836 /005-000/039-000 |
|  | Item no.: 232-840/005-000 Female connector for rail-mount terminal blocks; straight; Pin spacing 7.5 mm; 10-pole | 232-840 /005-000 |
|  | Item no.: 232-842/005-000 Female connector for rail-mount terminal blocks; straight; Pin spacing 7.5 mm; 12-pole | 232-842 /005-000 |
|  | Item no.: 722-132/005-000 Female connector for rail-mount terminal blocks; straight; 100% protected against mismatching; Pin spacing 5 mm; 2-pole | 722-132 /005-000 |
|  | Item no.: 722-132/005-000/039-000 Female connector for rail-mount terminal blocks; straight; 100% protected against mismatching; Locking lever; Pin spacing 5 mm; 3-pole | 722-132 /005-000/039-000 |
|  | Item no.: 722-133/005-000 Female connector for rail-mount terminal blocks; straight; 100% protected against mismatching; Pin spacing 5 mm; 3-pole | 722-133 /005-000 |
|  | Item no.: 722-133/005-000/039-000 Female connector for rail-mount terminal blocks; straight; 100% protected against mismatching; Locking lever; Pin spacing 5 mm; 3-pole | 722-133 /005-000/039-000 |
|  | Item no.: 722-134/005-000 Female connector for rail-mount terminal blocks; straight; 100% protected against mismatching; Pin spacing 5 mm; 4-pole | 722-134 /005-000 |
| | Item no.: 722-134/005-000/039-000 Female connector for rail-mount terminal blocks; straight; 100% protected against mismatching; | |















| | | |
|--|---|-----------------------------|
|  | Locking lever; Pin spacing 5 mm; 4-pole | 722-134 /005-000/039-000 |
|  | Item no.: 722-135/005-000 Female connector for rail-mount terminal blocks; straight; 100% protected against mismatching; Pin spacing 5 mm; 5-pole | 722-135 /005-000 |
|  | Item no.: 722-135/005-000/039-000 Female connector for rail-mount terminal blocks; straight; 100% protected against mismatching; Locking lever; Pin spacing 5 mm; 5-pole | 722-135 /005-000/039-000 |
|  | Item no.: 722-136/005-000 Female connector for rail-mount terminal blocks; straight; 100% protected against mismatching; Pin spacing 5 mm; 6-pole | 722-136 /005-000 |
|  | Item no.: 722-136/005-000/039-000 Female connector for rail-mount terminal blocks; straight; 100% protected against mismatching; Locking lever; Pin spacing 5 mm; 6-pole | 722-136 /005-000/039-000 |
|  | Item no.: 722-137/005-000 Female connector for rail-mount terminal blocks; straight; 100% protected against mismatching; Pin spacing 5 mm; 7-pole | 722-137 /005-000 |
|  | Item no.: 722-137/005-000/039-000 Female connector for rail-mount terminal blocks; straight; 100% protected against mismatching; Locking lever; Pin spacing 5 mm; 7-pole | 722-137 /005-000/039-000 |
|  | Item no.: 722-138/005-000 Female connector for rail-mount terminal blocks; straight; 100% protected against mismatching; Pin spacing 5 mm; 8-pole | 722-138 /005-000 |
|  | Item no.: 722-138/005-000/039-000 Female connector for rail-mount terminal blocks; straight; 100% protected against mismatching; Locking lever; Pin spacing 5 mm; 8-pole | 722-138 /005-000/039-000 |
|  | Item no.: 722-139/005-000 Female connector for rail-mount terminal blocks; straight; 100% protected against mismatching; Pin spacing 5 mm; 9-pole | 722-139 /005-000 |
|  | Item no.: 722-139/005-000/039-000 Female connector for rail-mount terminal blocks; straight; 100% protected against mismatching; Locking lever; Pin spacing 5 mm; 9-pole | 722-139 /005-000/039-000 |
|  | Item no.: 722-140/005-000 Female connector for rail-mount terminal blocks; straight; 100% protected against mismatching; Pin spacing 5 mm; 10-pole | 722-140 /005-000 |
|  | Item no.: 722-140/005-000/039-000 Female connector for rail-mount terminal blocks; straight; 100% protected against mismatching; Locking lever; Pin spacing 5 mm; 10-pole | 722-140 /005-000/039-000 |
|  | Item no.: 722-141/005-000 Female connector for rail-mount terminal blocks; straight; 100% protected against mismatching; Pin spacing 5 mm; 11-pole | 722-141 /005-000 |
| | Item no.: 722-142/005-000 Female connector for rail-mount terminal blocks; straight; 100% protected against mismatching; Pin | |

| | | |
|--|--|-----------------------------|
|  | spacing 5 mm; 12-pole | 722-142 /005-000 |
|  | Item no.: 722-142/005-007/039-000 Female connector for rail-mount terminal blocks; straight; 100% protected against mismatching; Locking lever; Pin spacing 5 mm; 12-pole | 722-142 /005-00 /039-000 |
|  | Item no.: 722-143/005-000 Female connector for rail-mount terminal blocks; angled; 100% protected against mismatching; Pin spacing 5 mm; 13-pole | 722-143 /005-000 |
|  | Item no.: 722-144/005-000 Female connector for rail-mount terminal blocks; straight; 100% protected against mismatching; Pin spacing 5 mm; 14-pole | 722-144 /005-000 |
|  | Item no.: 722-144/005-000/039-000 Female connector for rail-mount terminal blocks; straight; 100% protected against mismatching; Locking lever; Pin spacing 5 mm; 14-pole | 722-144 /005-000/039-000 |
|  | Item no.: 722-145/005-000 Female connector for rail-mount terminal blocks; straight; 100% protected against mismatching; Pin spacing 5 mm; 15-pole | 722-145 /005-000 |
|  | Item no.: 722-146/005-000 Female connector for rail-mount terminal blocks; straight; 100% protected against mismatching; Pin spacing 5 mm; 16-pole | 722-146 /005-000 |
|  | Item no.: 722-146/005-000/039-000 Female connector for rail-mount terminal blocks; straight; 100% protected against mismatching; Locking lever; Pin spacing 5 mm; 16-pole | 722-146 /005-000/039-000 |
|  | Item no.: 722-150/005-000 Female connector for rail-mount terminal blocks; straight; 100% protected against mismatching; Pin spacing 5 mm; 20-pole | 722-150 /005-000 |
|  | Item no.: 722-150/005-000/039-000 Female connector for rail-mount terminal blocks; straight; 100% protected against mismatching; Locking lever; Pin spacing 5 mm; 20-pole | 722-150 /005-000/039-000 |
|  | Item no.: 722-232/005-000 Female connector for rail-mount terminal blocks; angled; 100% protected against mismatching; Pin spacing 5 mm; 3-pole | 722-232 /005-000 |
|  | Item no.: 722-232/005-000/039-000 Female connector for rail-mount terminal blocks; straight; 100% protected against mismatching; Locking lever; Pin spacing 5 mm; 3-pole | 722-232 /005-000/039-000 |
|  | Item no.: 722-233/005-000 Female connector for rail-mount terminal blocks; angled; 100% protected against mismatching; Pin spacing 5 mm; 3-pole | 722-233 /005-000 |
|  | Item no.: 722-233/005-000/039-000 Female connector for rail-mount terminal blocks; angled; 100% protected against mismatching; Locking lever; Pin spacing 5 mm; 3-pole | 722-233 /005-000/039-000 |
| | Item no.: 722-234/005-000 Female connector for rail-mount terminal blocks; angled; 100% protected against mismatching; Pin | |

















| | | |
|--|---|-----------------------------|
|  | spacing 5 mm; 4-pole | 722-234 /005-000 |
|  | Item no.: 722-234/005-000/039-000 Female connector for rail-mount terminal blocks; straight; 100% protected against mismatching; Locking lever; Pin spacing 5 mm; 4-pole | 722-234 /005-000/039-000 |
|  | Item no.: 722-235/005-000 Female connector for rail-mount terminal blocks; angled; 100% protected against mismatching; Pin spacing 5 mm; 5-pole | 722-235 /005-000 |
|  | Item no.: 722-235/005-000/039-000 Female connector for rail-mount terminal blocks; angled; 100% protected against mismatching; Locking lever; Pin spacing 5 mm; 5-pole | 722-235 /005-000/039-000 |
|  | Item no.: 722-236/005-000 Female connector for rail-mount terminal blocks; angled; 100% protected against mismatching; Pin spacing 5 mm; 6-pole | 722-236 /005-000 |
|  | Item no.: 722-236/005-000/039-000 Female connector for rail-mount terminal blocks; angled; 100% protected against mismatching; Locking lever; Pin spacing 5 mm; 6-pole | 722-236 /005-000/039-000 |
|  | Item no.: 722-237/005-000 Female connector for rail-mount terminal blocks; angled; 100% protected against mismatching; Pin spacing 5 mm; 7-pole | 722-237 /005-000 |
|  | Item no.: 722-237/005-000/039-000 Female connector for rail-mount terminal blocks; angled; 100% protected against mismatching; Locking lever; Pin spacing 5 mm; 7-pole | 722-237 /005-000/039-000 |
|  | Item no.: 722-238/005-000 Female connector for rail-mount terminal blocks; angled; 100% protected against mismatching; Pin spacing 5 mm; 8-pole | 722-238 /005-000 |
|  | Item no.: 722-239/005-000 Female connector for rail-mount terminal blocks; angled; 100% protected against mismatching; Pin spacing 5 mm; 9-pole | 722-239 /005-000 |
|  | Item no.: 722-239/005-000/039-000 Female connector for rail-mount terminal blocks; angled; 100% protected against mismatching; Locking lever; Pin spacing 5 mm; 9-pole | 722-239 /005-000/039-000 |
|  | Item no.: 722-240/005-000 Female connector for rail-mount terminal blocks; angled; 100% protected against mismatching; Pin spacing 5 mm; 10-pole | 722-240 /005-000 |
|  | Item no.: 722-240/005-000/039-000 Female connector for rail-mount terminal blocks; angled; 100% protected against mismatching; Locking lever; Pin spacing 5 mm; 10-pole | 722-240 /005-000/039-000 |
|  | Item no.: 722-241/005-000 Female connector for rail-mount terminal blocks; straight; 100% protected against mismatching; Pin spacing 5 mm; 11-pole | 722-241 /005-000 |
| | Item no.: 722-242/005-000 Female connector for rail-mount terminal blocks; angled; 100% protected against mismatching; Pin | |

















| | | |
|--|---|-----------------------------|
|  | spacing 5 mm; 12-pole | 722-242 /005-000 |
|  | Item no.: 722-242/005-000/039-000 Female connector for rail-mount terminal blocks; angled; 100% protected against mismatching; Locking lever; Pin spacing 5 mm; 12-pole | 722-242 /005-000/039-000 |
|  | Item no.: 722-243/005-000 Female connector for rail-mount terminal blocks; angled; 100% protected against mismatching; Pin spacing 5 mm; 13-pole | 722-243 /005-000 |
|  | Item no.: 722-244/005-000 Female connector for rail-mount terminal blocks; angled; 100% protected against mismatching; Pin spacing 5 mm; 14-pole | 722-244 /005-000 |
|  | Item no.: 722-244/005-000/039-000 Female connector for rail-mount terminal blocks; angled; 100% protected against mismatching; Locking lever; Pin spacing 5 mm; 14-pole | 722-244 /005-000/039-000 |
|  | Item no.: 722-246/005-000 Female connector for rail-mount terminal blocks; angled; 100% protected against mismatching; Pin spacing 5 mm; 16-pole | 722-246 /005-000 |
|  | Item no.: 722-246/005-000/039-000 Female connector for rail-mount terminal blocks; angled; 100% protected against mismatching; Locking lever; Pin spacing 5 mm; 16-pole | 722-246 /005-000/039-000 |
|  | Item no.: 722-250/005-000 Female connector for rail-mount terminal blocks; angled; 100% protected against mismatching; Pin spacing 5 mm; 20-pole | 722-250 /005-000 |
| End plate | | |
|  | Item no.: 280-316 End and intermediate plate; 2.5 mm thick | 280-316 |
|  | Item no.: 280-317 End and intermediate plate; 2.5 mm thick | 280-317 |
| Protective Warning Marker | | |
|  | Item no.: 280-415 Protective warning marker; with high-voltage symbol, black; for 5 terminal blocks | 280-415 |
| tools | | |
|  | Item no.: 210-657 Operating tool with partially insulated shaft; Blade (3.5 x 0.5) mm; short | 210-657 |
|  | Item no.: 210-658 Operating tool with partially insulated shaft; Blade (3.5 x 0.5) mm; short; angled | 210-658 |
|  | Item no.: 210-720 Operating tool with partially insulated shaft; Type 2, blade (3.5 x 0.5) mm | 210-720 |
| ferrule | | |
|  | Item no.: 216-101 Ferrule; Sleeve for 0.5 mm ² / AWG 22; uninsulated; electro-tin plated | 216-101 |

















| | | |
|--|--|---------|
|  | Item no.: 216-102 Ferrule; Sleeve for 0.75 mm ² / AWG 20; uninsulated; electro-tin plated | 216-102 |
|  | Item no.: 216-103 Ferrule; Sleeve for 1 mm ² / AWG 18; uninsulated; electro-tin plated | 216-103 |
|  | Item no.: 216-104 Ferrule; Sleeve for 1.5 mm ² / AWG 16; uninsulated; electro-tin plated | 216-104 |
|  | Item no.: 216-201 Ferrule; Sleeve for 0.5 mm ² / 20 AWG; insulated; electro-tin plated | 216-201 |
|  | Item no.: 216-202 Ferrule; Sleeve for 0.75 mm ² / 18 AWG; insulated; electro-tin plated | 216-202 |
|  | Item no.: 216-203 Ferrule; Sleeve for 1 mm ² / AWG 18; insulated; electro-tin plated | 216-203 |
|  | Item no.: 216-204 Ferrule; Sleeve for 1.5 mm ² / AWG 16; insulated; electro-tin plated | 216-204 |
| | Item no.: 216-301 Ferrule; Sleeve for 0.25 mm ² / AWG 24; insulated; electro-tin plated | 216-301 |
|  | Item no.: 216-302 Ferrule; Sleeve for 0.34 mm ² / 22 AWG; insulated; electro-tin plated | 216-302 |
| General accessories | | |
|  | Item no.: 231-162/003-000 Male connector for rail-mount terminal blocks; 1.2 x 1.2 mm pins; straight; Pin spacing 5 mm; 2-pole / 003-000 | 231-162 |
|  | Item no.: 231-163/003-000 Male connector for rail-mount terminal blocks; 1.2 x 1.2 mm pins; straight; Pin spacing 5 mm; 3-pole / 003-000 | 231-163 |
|  | Item no.: 231-164/003-000 Male connector for rail-mount terminal blocks; 1.2 x 1.2 mm pins; straight; Pin spacing 5 mm; 4-pole / 003-000 | 231-164 |
|  | Item no.: 231-165/003-000 Male connector for rail-mount terminal blocks; 1.2 x 1.2 mm pins; straight; Pin spacing 5 mm; 5-pole / 003-000 | 231-165 |
|  | Item no.: 231-166/003-000 Male connector for rail-mount terminal blocks; 1.2 x 1.2 mm pins; straight; Pin spacing 5 mm; 6-pole / 003-000 | 231-166 |
|  | Item no.: 231-167/003-000 Male connector for rail-mount terminal blocks; 1.2 x 1.2 mm pins; straight; Pin spacing 5 mm; 7-pole / 003-000 | 231-167 |
|  | Item no.: 231-168/003-000 Male connector for rail-mount terminal blocks; 1.2 x 1.2 mm pins; straight; Pin spacing 5 mm; 8-pole / 003-000 | 231-168 |
|  | Item no.: 231-169/003-000 Male connector for rail-mount terminal blocks; 1.2 x 1.2 mm pins; straight; Pin spacing 5 mm; 9-pole / 003-000 | 231-169 |



















| | | |
|--|---|---------|
|  | Item no.: 231-170/003-000 Male connector for rail-mount terminal blocks; 1.2 x 1.2 mm pins; straight; Pin spacing 5 mm; 10-pole / 003-000 | 231-170 |
|  | Item no.: 231-171/003-000 Male connector for rail-mount terminal blocks; 1.2 x 1.2 mm pins; straight; Pin spacing 5 mm; 11-pole / 003-000 | 231-171 |
|  | Item no.: 231-172/003-000 Male connector for rail-mount terminal blocks; 1.2 x 1.2 mm pins; straight; Pin spacing 5 mm; 12-pole / 003-000 | 231-172 |
|  | Item no.: 231-176/003-000 Male connector for rail-mount terminal blocks; 1.2 x 1.2 mm pins; straight; Pin spacing 5 mm; 16-pole / 003-000 | 231-176 |
|  | Item no.: 231-180/003-000 Male connector for rail-mount terminal blocks; 1.2 x 1.2 mm pins; straight; Pin spacing 5 mm; 20-pole / 003-000 | 231-180 |
|  | Item no.: 231-668 Lockout caps; for covering unused clamping units | 231-668 |
|  | Item no.: 231-669 Lockout caps; for covering unused clamping units | 231-669 |
|  | Item no.: 249-105 Group marker carrier | 249-105 |
|  | Item no.: 280-801 Empty component plug housing | 280-801 |
|  | Item no.: 280-801/281-411 Component plug; for carrier terminal blocks; 2-pole; with diode 1N4007; 5 mm wide / 281-411 | 280-801 |
|  | Item no.: 280-801/281-413 Component plug; for carrier terminal blocks; 1-pole; LED (red); 24 VDC; 5 mm wide / 281-413 | 280-801 |
|  | Item no.: 280-801/281-414 Component plug; for carrier terminal blocks; 1-pole; LED (red); 48 VDC; 5 mm wide / 281-414 | 280-801 |
|  | Item no.: 280-801/281-415 Component plug; for carrier terminal blocks; 1-pole; LED (red); 5 mm wide / 281-415 | 280-801 |
|  | Item no.: 280-801/281-416 Component plug; for carrier terminal blocks; 1-pole; LED (red); 5 mm wide / 281-416 | 280-801 |
|  | Item no.: 280-801/281-417 Component plug; for carrier terminal blocks; 1-pole; 5 mm wide / 281-417 | 280-801 |
| | Item no.: 280-801/281-418 Component plug; for carrier terminal blocks; 1-pole; 5 mm wide / 281-418 | 280-801 |



















| | | | |
|--|---|----------|---------|
|  | Item no.: 280-801/281-420 Component plug; for carrier terminal blocks; 2-pole; with LED and recovery diode; 5 mm wide | 1281-420 | 280-801 |
|  | Item no.: 280-801/281-421 Component plug; for carrier terminal blocks; 2-pole; with LED and recovery diode; 5 mm wide | 1281-421 | 280-801 |
|  | Item no.: 280-802 Empty component plug housing | | 280-802 |
|  | Item no.: 280-804 Empty component plug housing; 10 mm wide; Type 3; 4-pole | | 280-804 |
|  | Item no.: 281-511 Fuse plug; with pull-tab; for miniature metric fuses 5 x 20 mm and 5 x 25 mm; without blown fuse indication; 6 mm wide | | 281-511 |
|  | Item no.: 281-512 Fuse plug; with pull-tab; for miniature metric fuses 5 x 20 mm and 5 x 25 mm; with port for LED; 6 mm wide | | 281-512 |
|  | Item no.: 281-512/281-417 Fuse plug; with pull-tab; for miniature metric fuses 5 x 20 mm and 5 x 25 mm; with blown fuse indication by neon lamp; 230 V; 6 mm wide | 1281-417 | 281-512 |
|  | Item no.: 281-512/281-418 Fuse plug; with pull-tab; for miniature metric fuses 5 x 20 mm and 5 x 25 mm; with blown fuse indication by neon lamp; 120 V; 6 mm wide | 1281-418 | 281-512 |
|  | Item no.: 281-512/281-501 Fuse plug; with pull-tab; for miniature metric fuses 5 x 20 mm and 5 x 25 mm; with LED indicator; 24 V AC/DC; 6 mm wide | 1281-501 | 281-512 |
|  | Item no.: 286-110 Empty component plug housing; Type 9; 10 mm wide; 4-pole | | 286-110 |
|  | Item no.: 286-111 Empty component plug housing; Type 10; 15 mm wide; 6-pole | | 286-111 |
|  | Item no.: 286-112 Empty component plug housing; Type 11; 20 mm wide; 8-pole | | 286-112 |
|  | Item no.: 286-113 Empty component plug housing; Type 12; 25 mm wide; 10-pole | | 286-113 |
|  | Item no.: 286-304 Relay module; Nominal input voltage: 24 VDC; 1 changeover contact; Limiting continuous current: 7 A; Red status indicator; Module width: 15 mm | | 286-304 |
|  | Item no.: 286-304/004-000 Relay module; Nominal input voltage: 24 VDC; 1 changeover contact; Limiting continuous current: 7 A; Path; Red status indicator; Module width: 15 mm | 1004-000 | 286-304 |
|  | Item no.: 286-307/004-000 Relay module; Nominal input voltage: 110 VDC; 1 changeover contact; Limiting continuous current: 7 A; Path; Red status indicator; Module width: 15 mm | 1004-000 | 286-307 |

| | | |
|--|---|---------------------|
|  | Item no.: 286-312 Relay module; Relay with 2 changeover contacts (2u) | 286-312 |
|  | Item no.: 286-312/004-000 Relay module; Nominal input voltage: 24 VDC; 2 changeover contacts; Limiting continuous current: 7 A; Path; Red status indicator; Module width: 20 mm | 286-312 /004-000 |
|  | Item no.: 286-316 Relay module; Nominal input voltage: 220 VDC; 2 changeover contacts; Limiting continuous current: 7 A; Red status indicator; Module width: 20 mm | 286-316 |
|  | Item no.: 286-320 Relay module; Nominal input voltage: 24 VDC; 1 break and 1 make contact; Limiting continuous current: 6 A; Red status indicator; Module width: 20 mm | 286-320 |
|  | Item no.: 286-320/004-000 Relay module; Nominal input voltage: 24 VDC; 1 break and 1 make contact; Path; Red status indicator; Module width: 20 mm | 286-320 /004-000 |
|  | Item no.: 286-328 Relay module; Nominal input voltage: 24 VDC; 2 make contact; Limiting continuous current: 6 A; Red status indicator; Module width: 20 mm | 286-328 |
|  | Item no.: 286-328/004-000 Relay module; Nominal input voltage: 24 VDC; 2 make contact; Limiting continuous current: 6 A; Path; Red status indicator; Module width: 20 mm | 286-328 /004-000 |
|  | Item no.: 286-336/001-000 Relay module; Nominal input voltage: 24 VDC; 2 break and 2 make contacts; Red status indicator; Module width: 25 mm | 286-336 /001-000 |
|  | Item no.: 286-344/004-000 Relay module; Nominal input voltage: 24 VDC; 3 break contacts and 1 make contact; Path; Red status indicator; Module width: 25 mm | 286-344 /004-000 |
|  | Item no.: 286-352/004-000 Relay module; Nominal input voltage: 24 VDC; 4 make contacts; Limiting continuous current: 5 A; Path; Red status indicator; Module width: 25 mm | 286-352 /004-000 |
|  | Item no.: 286-364 Relay module; Nominal input voltage: 24 VDC; 1 make contact; Limiting continuous current: 5 A; Red status indicator; Module width: 10 mm | 286-364 |
|  | Item no.: 286-364/004-000 Relay module; Nominal input voltage: 24 VDC; 1 make contact; Path; Red status indicator; Module width: 10 mm | 286-364 /004-000 |
|  | Item no.: 286-368 Relay module; Nominal input voltage: 24 VDC; 1 break contact; Limiting continuous current: 5 A; Red status indicator; Module width: 10 mm | 286-368 |
|  | Item no.: 286-368/004-000 Relay module; Nominal input voltage: 24 VDC; 1 break contact; Limiting continuous current: 5 A; Path; Red status indicator; 10 mm wide | 286-368 /004-000 |
|  | Item no.: 286-376 Relay module; Nominal input voltage: 24 VDC; 1 make contact; Limiting continuous current: 5 A; for switching higher DC loads; Red status indicator; Module width: 15 mm | 286-376 |
|  | Item no.: 286-380 Bistable relay module; Nominal input voltage: 24 VDC; 1 changeover contact; Limiting continuous current: 6 A; Red status indicator; Module width: 15 mm | 286-380 |



















| | | | |
|--|---|----------|---------|
|  | Item no.: 286-381 Bistable relay module; Nominal input voltage: 24 VDC; 1 changeover contact; Limiting continuous current: 6 A; Red status indicator; Module width: 15 mm | | 286-381 |
|  | Item no.: 286-394/004-000 Relay module; Nominal input voltage: 24 VDC; 1 changeover contact; Path; Red status indicator; Module width: 15 mm | /UU4-UUU | 286-394 |
|  | Item no.: 286-427 Timer relay module; Nominal input voltage: 24 VDC; Limiting continuous current: 5 A; Pulse lengthening: 1 ... 10 s; Red status indicator; Module width: 20 mm | | 286-427 |
|  | Item no.: 286-507 Relay module; Nominal input voltage: 115 VAC; 1 changeover contact; Limiting continuous current: 7 A; Red status indicator; Module width: 15 mm | | 286-507 |
|  | Item no.: 286-508 Relay module; Nominal input voltage: 230 VAC; 1 changeover contact; Limiting continuous current: 7 A; Red status indicator; Module width: 15 mm | | 286-508 |
|  | Item no.: 286-516 Relay module; Nominal input voltage: 230 VAC; 2 changeover contacts; Limiting continuous current: 7 A; Red status indicator; Module width: 15 mm | | 286-516 |
|  | Item no.: 286-573 Latching relay module; Nominal input voltage: 24 VDC; 1 changeover contact; Limiting continuous current: 6 A; Red status indicator; Module width: 17 mm | | 286-573 |
|  | Item no.: 286-575 Stromstoßschaltermodul; Eingangsnennspannung DC 24 V; 1 Wechsler; Grenzdauerstrom 3 A; Bahn; Statusanzeige rot; 22 mm Baubreite | | 286-575 |
|  | Item no.: 286-604/004-000 Timer relay module; Nominal input voltage: 24 VDC; Limiting continuous current: 6 A; On-delay: 10 ... 100 s; Red status indicator; Module width: 20 mm | /UU4-UUU | 286-604 |
|  | Item no.: 286-640 Timer relay module; Nominal input voltage: 24 VDC; Limiting continuous current: 6 A; Path; Multifunction/Multitime; Yellow status indicator; Module width: 6 mm | | 286-640 |
|  | Item no.: 286-640/004-000 Multifunction timing relay module; Relay with 1 changeover contact (1u); 4 time ranges; for railway operations; 4 functions | /UU4-UUU | 286-640 |
|  | Item no.: 286-661 Current flow monitoring module; AC current flow monitoring module; 80 mA ... 6 A | | 286-661 |
|  | Item no.: 286-662 Current flow monitoring module; DC current flow monitoring module; 0.4 A ... 3.5 A; Relay with 1 make contact (1a) | | 286-662 |
|  | Item no.: 286-664 Current flow monitoring module; AC current flow monitoring module; 1 A ... 10 A; Adjustable; Relay with 1 changeover contact (1u) | | 286-664 |
|  | Item no.: 286-665 Current flow monitoring module; Relay with 1 changeover contact (1u); adjustable | | 286-665 |
|  | Item no.: 286-721 Optocoupler module; Nominal input voltage: 24 VDC; Output voltage range: 15 ... 30 VDC; Limiting continuous current: 5 A; 3-wire connection/low-side switching; Red status indicator; Module width: 15 mm | | 286-721 |
| | Item no.: 286-723 Optocoupler module; Nominal input voltage: 24 VDC; Output voltage range: 15 ... 30 VDC; Limiting | | |















| | | |
|--|---|---------------------|
|  | continuous current: 4 A; 3-wire connection/high-side switching; Red status indicator; Module width: 15 mm | 286-723 |
|  | Item no.: 286-725 Optocoupler module; Input AC/DC 10 V ... 30 V; Output DC 24 V/ 1 mA ... 0.5 A; negative switching | 286-725 |
|  | Item no.: 286-742 S0 interface power supply; Input voltage: 230 VAC; S0 interface | 286-742 |
|  | Item no.: 286-752 Optocoupler module; Nominal input voltage: 24 VDC; Output voltage range: 20 ... 30 VDC; Limiting continuous current: 0.5 A; 3-wire connection/high-side switching; Frequency: 25 kHz; Red status indicator; Module width: 15 mm | 286-752 |
|  | Item no.: 286-752/002-000 Optocoupler module; Red status indicator | 286-752 /002-000 |
|  | Item no.: 286-790 Optocoupler module | 286-790 |
|  | Item no.: 286-791 Optocoupler module; Nominal input voltage: 24 VDC; Output voltage range: 20 ... 60 VDC; Limiting continuous current: 0.1 A; 2-wire connection; Frequency: 3 kHz; Red status indicator; Module width: 10 mm | 286-791 |
|  | Item no.: 286-792 Optocoupler module; Red status indicator | 286-792 |
|  | Item no.: 286-794 Optocoupler module; Nominal input voltage: 24 VDC; Output voltage range: 20 ... 60 VDC; Limiting continuous current: 0.1 A; 2-wire connection; Red status indicator; Module width: 10 mm | 286-794 |
|  | Item no.: 286-797 Optocoupler module; Red status indicator | 286-797 |
|  | Item no.: 286-803 Component module with diode | 286-803 |
|  | Item no.: 286-805 Component module with diode | 286-805 |
|  | Item no.: 286-807 Component module with diode; with 7 pcs; Diode 1N4007; with common anode | 286-807 |
|  | Item no.: 286-809 Component module with diode | 286-809 |
|  | Item no.: 286-822 Component module with LED; Red LED; with common cathode | 286-822 |
|  | Item no.: 286-826 AND gate module with 6 inputs | 286-826 |
|  | Item no.: 286-830 Bridge rectifier module; Input voltage: 24 VAC; with varistor protective circuit | 286-830 |
|  | Item no.: 286-831 Surge suppression module for signal technology; Nominal voltage: 24 VAC/DC; for 2 signal paths with common surge arrester; plugged on rail-mount terminal block, 15 mm wide | 286-831 |
| | Item no.: 286-832 | |















| | | | |
|--|---|----------|---------|
|  | Surge suppression module for signal technology; Nominal voltage: 24 VAC/DC; for 2 signal paths with common surge arrester; pluggable on rail-mount terminal block, 20 mm wide | | 286-832 |
| | Item no.: 286-833 | | |
|  | Surge suppression module for signal technology; Nominal voltage: 24 VDC; for 1 signal path; plugged on rail-mount terminal block, 15 mm wide | | 286-833 |
| | Item no.: 286-834 | | |
|  | Surge suppression module for signal technology; Nominal voltage: 12 VDC; for 2 signal paths with common surge arrester; pluggable on rail-mount terminal block, 20 mm wide | | 286-834 |
| | Item no.: 286-834/024-000 | | |
|  | Surge suppression module for signal technology; Nominal voltage: 24 VDC; for 2 signal paths with common surge arrester; pluggable on rail-mount terminal block, 15 mm wide | /024-000 | 286-834 |
| | Item no.: 286-835 | | |
|  | Surge suppression module for signal technology; Nominal voltage: 230 VAC; for 2 signal paths with common surge arrester; plugged on rail-mount terminal block, 15 mm wide | | 286-835 |
| | Item no.: 286-835/115-000 | | |
|  | Surge suppression module for signal technology; Nominal voltage: 115 VAC; for 2 signal paths with common surge arrester; plugged on rail-mount terminal block, 15 mm wide | /115-000 | 286-835 |
| | Item no.: 286-836 | | |
|  | Surge suppression module for signal technology; Nominal voltage: 24 VAC/DC; for 2 signal paths with common surge arrester; plugged on rail-mount terminal block, 15 mm wide | | 286-836 |
| | Item no.: 286-838 | | |
|  | Surge suppression module for signal technology; Nominal voltage: 230 VAC; for 2 signal paths with common surge arrester; with visual indicator | | 286-838 |
| | Item no.: 286-840 | | |
|  | Bridge rectifier module; Input voltage: 250 VAC; with varistor protective circuit | | 286-840 |
| | Item no.: 286-841 | | |
|  | Surge suppression module for signal technology; Nominal voltage: 220 VDC; for 2 signal paths with common surge arrester; pluggable on rail-mount terminal block, 25 mm wide | | 286-841 |
| | Item no.: 286-842 | | |
|  | Surge suppression module for signal technology; Nominal voltage: 230 VAC; for 2 signal paths with common surge arrester; pluggable on rail-mount terminal block, 25 mm wide | | 286-842 |
| | Item no.: 286-843 | | |
|  | Surge suppression module for signal technology; Nominal voltage: 115 VAC; for 2 signal paths with common surge arrester; pluggable on rail-mount terminal block, 25 mm wide | | 286-843 |
| | Item no.: 286-844 | | |
|  | Surge suppression module for signal technology; for 2 signal paths with common surge arrester; pluggable on rail-mount terminal block, 25 mm wide | | 286-844 |
| | Item no.: 286-890 | | |
|  | Component module with fuse; for (5 x 20) mm microfuse; Nominal voltage: 24 VAC/DC | | 286-890 |
| | Item no.: 286-891 | | |
|  | Component module with fuse; for (5 x 20) mm microfuse; Nominal voltage: 230 VAC/DC | | 286-891 |
| | Item no.: 286-895 | | |
|  | Switching module; with changeover rocker switch; Switching voltage: 250 VAC; Switching current: 6 A | | 286-895 |
| | Item no.: 286-896 | | |
|  | Switching module; Changeover; 1-pole; with momentary switch | | 286-896 |















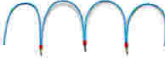

assembling

Item no.: 209-106

| | | |
|--|--|----------------------|
|  | Mounting carrier; for isolated mounting on DIN 35 rails | 209-106 |
|  | Item no.: 709-153 Cover; Type 1; suitable for cover carrier, type 1; 1 m long | 709-153 |
| Carrier rail | | |
|  | Item no.: 210-112 Steel carrier rail; 35 x 7.5 mm; 1 mm thick; 2 m long; slotted; according to EN 60715; "Hole width 25 mm | 210-112 |
|  | Item no.: 210-113 Steel carrier rail; 35 x 7.5 mm; 1 mm thick; 2 m long; unslotted; according to EN 60715 | 210-113 |
|  | Item no.: 210-114 Steel carrier rail; 35 x 15 mm; 1.5 mm thick; 2 m long; unslotted; similar to EN 60715 | 210-114 |
|  | Item no.: 210-115 Steel carrier rail; 35 x 7.5 mm; 1 mm thick; 2 m long; slotted; according to EN 60715; "Hole width 18 mm | 210-115 |
|  | Item no.: 210-118 Steel carrier rail; 35 x 15 mm; 2.3 mm thick; 2 m long; unslotted; according to EN 60715 | 210-118 |
|  | Item no.: 210-196 Aluminum carrier rail; 35 x 8.2 mm; 1.6 mm thick; 2 m long; unslotted; similar to EN 60715 | 210-196 |
|  | Item no.: 210-197 Steel carrier rail; 35 x 15 mm; 1.5 mm thick; 2 m long; slotted; similar to EN 60715 | 210-197 |
|  | Item no.: 210-198 Copper carrier rail; 35 x 15 mm; 2.3 mm thick; 2 m long; unslotted; according to EN 60715 | 210-198 |
|  | Item no.: 210-504 Steel carrier rail; 35 x 7.5 mm; 1 mm thick; 2 m long; slotted; galvanized; according to EN 60715 | 210-504 |
|  | Item no.: 210-505 Steel carrier rail; 35 x 7.5 mm; 1 mm thick; 2 m long; unslotted; galvanized; according to EN 60715 | 210-505 |
|  | Item no.: 210-506 Steel carrier rail; 35 x 15 mm; 1.5 mm thick; 2 m long; unslotted; galvanized; similar to EN 60715 | 210-506 |
|  | Item no.: 210-508 Steel carrier rail; 35 x 15 mm; 1.5 mm thick; 2 m long; slotted; galvanized; similar to EN 60715 | 210-508 |
| Marking accessories | | |
|  | Item no.: 2009-115 WMB-Inline; for Smart Printer; on reel; stretchable 5 - 5.2 mm; plain; snap-on type | 2009-115 |
|  | Item no.: 2009-115/000-002 WMB-Inline; for Smart Printer; on reel; stretchable 5 - 5.2 mm; plain; snap-on type | 2009-115 /UUU-UUZ |
|  | Item no.: 2009-115/000-006 WMB-Inline; for smartPRINTER; on reel; stretchable 5 - 5.2 mm; plain; snap-on type | 2009-115 /UUU-UU6 |
|  | Item no.: 2009-115/000-007 WMB-Inline; for Smart Printer; on reel; stretchable 5 - 5.2 mm; plain; snap-on type | 2009-115 /UUU-UU7 |

| | | | |
|--|---|----------|----------|
|  | Item no.: 2009-115/000-012 WMB-Inline; for smartPRINTER; on reel; stretchable 5 - 5.2 mm; plain; snap-on type | /000-012 | 2009-115 |
|  | Item no.: 2009-115/000-017 WMB-Inline; for Smart Printer; on reel; stretchable 5 - 5.2 mm; plain; snap-on type | /000-017 | 2009-115 |
|  | Item no.: 2009-115/000-023 WMB-Inline; for Smart Printer; on reel; stretchable 5 - 5.2 mm; plain; snap-on type | /000-023 | 2009-115 |
|  | Item no.: 2009-115/000-024 WMB-Inline; for smartPRINTER; on reel; stretchable 5 - 5.2 mm; plain; snap-on type | /000-024 | 2009-115 |
|  | Item no.: 793-501 WMB marking card; as card; not stretchable; plain; snap-on type | | 793-501 |
|  | Item no.: 793-501/000-002 WMB marking card; as card; not stretchable; plain; snap-on type | /000-002 | 793-501 |
|  | Item no.: 793-501/000-005 WMB marking card; as card; not stretchable; plain; snap-on type | /000-005 | 793-501 |
|  | Item no.: 793-501/000-006 WMB marking card; as card; not stretchable; plain; snap-on type | /000-006 | 793-501 |
|  | Item no.: 793-501/000-007 WMB marking card; as card; not stretchable; plain; snap-on type | /000-007 | 793-501 |
|  | Item no.: 793-501/000-012 WMB marking card; as card; not stretchable; plain; snap-on type | /000-012 | 793-501 |
|  | Item no.: 793-501/000-017 WMB marking card; as card; not stretchable; plain; snap-on type | /000-017 | 793-501 |
|  | Item no.: 793-501/000-023 WMB marking card; as card; not stretchable; plain; snap-on type | /000-023 | 793-501 |
|  | Item no.: 793-501/000-024 WMB marking card; as card; not stretchable; plain; snap-on type | /000-024 | 793-501 |
|  | Item no.: 793-5501 WMB marking card; as card; for terminal block width 5 - 17.5 mm; stretchable 5 - 5.2 mm; plain; snap-on type | | 793-5501 |
|  | Item no.: 793-5501/000-002 WMB marking card; as card; for terminal block width 5 - 17.5 mm; stretchable 5 - 5.2 mm; plain; snap-on type | /000-002 | 793-5501 |

| | | |
|--|---|----------------------|
|  | Item no.: 793-5501/000-005 WMB marking card; as card; stretchable 5 - 5.2 mm; plain; snap-on type | 793-5501 /000-005 |
|  | Item no.: 793-5501/000-006 WMB marking card; as card; stretchable 5 - 5.2 mm; plain; snap-on type | 793-5501 /000-006 |
|  | Item no.: 793-5501/000-007 WMB marking card; as card; stretchable 5 - 5.2 mm; plain; snap-on type | 793-5501 /000-007 |
|  | Item no.: 793-5501/000-012 WMB marking card; as card; stretchable 5 - 5.2 mm; plain; snap-on type | 793-5501 /000-012 |
|  | Item no.: 793-5501/000-017 WMB marking card; as card; stretchable 5 - 5.2 mm; plain; snap-on type | 793-5501 /000-017 |
|  | Item no.: 793-5501/000-023 WMB marking card; as card; stretchable 5 - 5.2 mm; plain; snap-on type | 793-5501 /000-023 |
|  | Item no.: 793-5501/000-024 WMB marking card; as card; stretchable 5 - 5.2 mm; plain; snap-on type | 793-5501 /000-024 |
| plug | | |
|  | Item no.: 280-850 Fuse plug; with soldered miniature fuse; 250 mA FF; 5 mm wide | 280-850 |
|  | Item no.: 280-850/281-413 Fuse plug; with soldered miniature fuse; with indicator lamp; LED (red); DC 15 - 30 V; 250 mA FF; 5 mm wide | 280-850 /281-413 |
|  | Item no.: 280-850/281-414 Fuse plug; with soldered miniature fuse; with indicator lamp; LED (red); DC 30 - 65 V; 250 mA FF; 5 mm wide | 280-850 /281-414 |
|  | Item no.: 280-850/281-415 Fuse plug; with soldered miniature fuse; with indicator lamp; LED (red); AC 15 - 30 V; 250 mA FF; 5 mm wide | 280-850 /281-415 |
|  | Item no.: 280-852 Fuse plug; with soldered miniature fuse; 500 mA FF; 5 mm wide | 280-852 |
|  | Item no.: 280-852/281-413 Fuse plug; with soldered miniature fuse; with indicator lamp; LED (red); DC 15 - 30 V; 500 mA FF; 5 mm wide | 280-852 /281-413 |
|  | Item no.: 280-852/281-414 Fuse plug; with soldered miniature fuse; with indicator lamp; LED (red); DC 30 - 65 V; 500 mA FF; 5 mm wide | 280-852 /281-414 |
|  | Item no.: 280-852/281-415 Fuse plug; with soldered miniature fuse; with indicator lamp; LED (red); AC 15 - 30 V; 500 mA FF; 5 mm wide | 280-852 /281-415 |

| | | |
|--|--|---------------------|
|  | Item no.: 280-854 Fuse plug; with soldered miniature fuse; 1 A FF; 5 mm wide | 280-854 |
|  | Item no.: 280-854/281-413 Fuse plug; with soldered miniature fuse; with indicator lamp; LED (red); DC 15 - 30 V; 1 A FF; 5 mm wide | 280-854 /281-413 |
|  | Item no.: 280-854/281-414 Fuse plug; with soldered miniature fuse; with indicator lamp; LED (red); DC 30 - 65 V; 1 A FF; 5 mm wide | 280-854 /281-414 |
|  | Item no.: 280-854/281-415 Fuse plug; with soldered miniature fuse; with indicator lamp; LED (red); AC 15 - 30 V; 1 A FF; 5 mm wide | 280-854 /281-415 |
|  | Item no.: 280-856 Fuse plug; with soldered miniature fuse; 2 A FF; 5 mm wide | 280-856 |
|  | Item no.: 280-856/281-413 Fuse plug; with soldered miniature fuse; with indicator lamp; LED (red); DC 15 - 30 V; 2 A FF; 5 mm wide | 280-856 /281-413 |
|  | Item no.: 280-856/281-414 Fuse plug; with soldered miniature fuse; with indicator lamp; LED (red); DC 30 - 65 V; 2 A FF; 5 mm wide | 280-856 /281-414 |
|  | Item no.: 280-856/281-415 Fuse plug; with soldered miniature fuse; with indicator lamp; LED (red); AC 15 - 30 V; 2 A FF; 5 mm wide | 280-856 /281-415 |
| Jumper | | |
|  | Item no.: 210-103 Wire commoning chain; insulated; 50 connections | 210-103 |
|  | Item no.: 210-123 Wire commoning chain; insulated; 50 connections | 210-123 |
|  | Item no.: 280-482 Comb-style jumper bar; insulated; 2-way; IN = IN terminal block | 280-482 |
|  | Item no.: 280-483 Comb-style jumper bar; insulated; 3-way; IN = IN terminal block | 280-483 |
|  | Item no.: 280-484 Comb-style jumper bar; insulated; 4-way; IN = IN terminal block | 280-484 |
|  | Item no.: 280-485 Comb-style jumper bar; insulated; 5-way; IN = IN terminal block | 280-485 |
|  | Item no.: 280-490 Comb-style jumper bar; insulated; 10-way; IN = IN terminal block | 280-490 |
|  | Item no.: 280-492 Alternate comb-style jumper bar; insulated; 2-way; IN = IN terminal block | 280-492 |
|  | Item no.: 709-110 Wire commoning chain; insulated; 4 connections; 3 x 110 mm | 709-110 |
| | Item no.: 709-111 | |



Wire commoning chain; insulated; 3 connections; 2 x 120 mm

709-111



Item no.: 709-112

Wire commoning chain; insulated; 3 connections; 2 x 170 mm

709-112

Insulation stop



Item no.: 280-470

Insulation stop; 0.08 - 0.2 mm² "s" (0.14 mm² "f-st"); 5 pieces/strip

280-470



Item no.: 280-471

Insulation stop; 0.25 - 0.5 mm²; 5 pieces/strip

280-471



Item no.: 280-472

Insulation stop; 0.75 - 1 mm²; 5 pieces/strip

280-472

Downloads

CAD/CAE - Smart Data

CAD data

3D Download 280-606

URL

Download

Subject to changes.